

TM Model “H”
High-Grade Model
Touch Screen Monitor

TMH Series

Instruction Manual

10.4” TMH-310-DC00-01
12.1” TMH-312-DC00-01

Introduction

Thank you for choosing Seedsware products.

This manual describes the functions of the TMH series.

Please read this manual carefully and use the product correctly.

Product will be referred to as "TM" hereinafter.

Copyrights and Trademarks

- The copyright of this instruction manual is rightfully owned by Seedsware Corporation.
- Reproduction and/or duplication of this product and/or this manual, in any form, in whole or in part, without permission are strictly prohibited.
- Contents of this product and/or this manual are subject to change without previous notice.
- Although all efforts have been made to ensure the accuracy of this product and/or the contents of this manual, should you notice any errors or have any questions, feel free to contact and notify us.
- Seedsware shall not be held liable in any way for damages or losses, nor be held responsible for any claims by a third party as a result of using this product.
- Other product and company names mentioned herein may be the trademarks of their respective owners.





Precautions for Safe Use

Please go through and follow the below precautions before use.

Safety Symbol Legends







Safety symbols listed below are noted throughout this manual for the TM to be used correctly.

These symbols stand for very important safety information as noted below:





 Warning	Indicates a procedure, condition, or statement that, if not strictly observed, could result in severe human injuries or loss of life.
 Caution	Indicates a procedure, condition, or statement that, if not strictly observed, could result in human injuries or property damage.
	Indicates a procedure, condition, or statement that is strictly prohibited for correct use of the equipment. (Forbidden)
	Indicates a procedure, condition, or statement that should be strictly followed for correct use of the equipment. (Mandatory)

Warnings



Warnings for Design

-  Designing switches that might cause human injuries and/or property damage on the touchscreen is strictly prohibited. Unintentional output signals due to malfunction of the main body, units, and/or cables can cause serious injuries. Design the system so that switches with major functions are equipped on devices other than the TM itself.
-  Designing safety related switches on TM is prohibited. Switches related to safety, such as emergency stop switches, should be made on a different hardware.
-  Do not use TM as a major warning system that may cause injuries/serious material damages, and or production stoppage. Control devices related to critical warning displays and warnings should be structured on an independent, redundant hardware system or a mechanical interlock.
-  TM is not intended for use for aircraft equipment, aerospace instruments, trunk line communication equipment, nuclear power control equipment, and medical equipment that concerns life support, and or other equipment that concerns high reliability and safety. It cannot be used for these purposes.
-  When using the TM for purposes that concern high reliability and safety functions and accuracy such as transport equipment (trains, automobiles, ship, etc.), crime/disaster prevention devices, various safety devices, and medical equipment that does not concern life support, be sure to have safety features including redundancy and false operation prevention measures incorporated into the entire system.
-  Display will black out when the backlight goes out. If mistakenly operated in this condition, it might result in improper operation. Do not design touch-switches that might cause human injuries and material damages on the TM

Warnings for Handling

-  Do not modify/disassemble the TM. It may cause fires and/or electric shocks
-  Do not use around flammable gas. It may cause explosions.
-  Do not put any kind of liquid, such as water, and metals into the product. It may cause fire and/or electrical shocks.
-  In an event abnormality is detected such as smoke, unusual odor or abnormal noise, pull the power plug and discontinue use. If continued use, it may cause fire or electrical shocks.

Warnings for Wiring

-  For wiring and installation, please refer to the manual and specifications in order to conduct it correctly. It may cause fires and/or electric shocks when not done properly.
-  Before installing the power cable, make sure power is not being supplied from power source. It may cause electrical shock if not followed.
-  Do not use power voltage other than what is specified. It may cause fires and/or electric shocks.

Cautions

Cautions for Disposal

- ❗ When disposing the product, please treat it as industrial waste.

Precautions for Safe Use

- ⊘ Do not press the display with strong pressure or hard objects. It may break the LCD panel and cause injuries.
- ❗ Please use this product within the specified ambient temperature and humidity range. If not used properly, it may cause malfunctions.
- ⊘ Do not press down on the display area of TM with sharp objects such as mechanical pencils or drivers. It may damage the display.
- ❗ If the surface of TM gets dirty, wipe with a dry, soft cloth dampened in a neutral detergent then wrung dry. Do not use thinner or organic solvents.
- ⊘ Do not use in areas where rapid temperature change can cause condensation. It may cause malfunctions.
- ⊘ In order to prevent product temperature from rising, do not use in areas where heat can be trapped. Also prevent storing in areas of high temperature.
- ⊘ Do not use or store TM in locations exposed to direct sunlight, fine particles, oil smoke and steam.
- ⊘ Do not use or store all precision equipment including the TM where shock or vibration can be applied.
- ⊘ Do not use or store in areas where gasified chemicals are diverged into the air or where chemical contamination can occur.
- ❗ When using power source with slow rise-time and fall-time, it may not operate correctly. Be sure to drop the voltage to 0V when turning the power back on after once turning off the power, before turning on the power. It may not boot correctly.

Handling of LCDs

- 1) The LCD display contains skin-irritating materials. If liquid materials flow out due to damage and comes in contact with skin, wash the area under water for at least 15 minutes and consult a doctor.
- 2) The LCD display might have uneven brightness according to the contents being displayed. This is not a malfunction.
- 3) Minute spots (dark or bright) may occur in the LCD display elements. This is a basic characteristic of the LCD display and not a malfunction.
- 4) When LCD display is viewed outside the specified view angel, the color might seem different. This is a basic characteristic of the LCD display and not a malfunction.
- 5) When displaying a same image for a long period of time, it might cause an image lag. This is a basic characteristic of the LCD display and not a malfunction.
In order to avoid image lags, change the displayed image periodically and avoid displaying the same image for a long period of time.

Handling of Analog Resistive Touch Screens

- 1) Applications that require a point on the touchscreen to be pressed for a long time may cause failures due to its structural features.
- 2) The touch screen is made of glass. Scratched glass will break easily. Handle carefully so that the glass does not come in contact with other glass and/or hard objects.
- 3) Due to the characteristics of the touch screen, the area just outside the display area will be read as a coordinate when touched. Please keep this in mind when designing an application
- 4) The coordinates of the touch screen will become misaligned due to aging or its operating environment. Correct the coordinates by coordination calibration as necessary. Refer to "[4.4 Calibration](#)" for details.

Table of Contents

1.	Features	1
1.1	Features.....	2
2.	Product Configuration	3
2.1	Standard Accessories	4
2.2	Names and Functions of Each Parts	5
2.3	Panel Installation	6
2.4	Installing to Stands	9
2.5	Wiring.....	10
2.6	Operations	13
3.	OSD.....	14
3.1	OSD Menu	15
3.2	OSD Menu Operation	16
4.	Mouse Emulation Software	18
4.1	System Requirements	19
4.2	Installing Procedure	20
4.3	Multi-monitor Setting.....	25
4.4	Calibration.....	26
5.	Maintenance	29
5.1	Maintenance	30
6.	Troubleshooting	31
6.1	Display	32
6.2	Touch Screen.....	33
7.	Others.....	34
7.1	Warranty and Repair.....	35
7.2	Production Discontinuance	36
7.3	Inquiries	37

1. Features

Chapter Contents

1.1	Features	2
-----	----------------	---

1.1 Features

- 2 Signal input interfaces
 - DVI Interface (DVI connector)
 - Analog RGB Interface (D-Sub15 pin (mini) connector)
- DC power input (12V/24V) compliant
- USB (Type B) for the touch screen interface
- Long life for industrial equipment/ high luminance LCD
- Analog resistive touch screen
- Possible to realize the same operation environment as the mouse
- Multi-display
- Contrast function
- Brightness adjusting function
- Product Certifications : UL61010 (UL/cUL)

2. Product Configuration

Chapter Contents

2.1	Standard Accessories	4
2.2	Names and Functions of Each Parts	5
2.3	Panel Installation	6
2.4	Installing to Stands	9
2.5	Wiring	10
2.6	Operations	13

2.1 Standard Accessories

• Accessory list 2pc

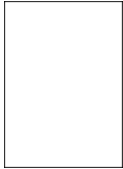

• Installation Guide 2pc

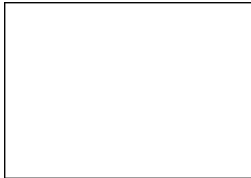

• Mounting Bracket 1set (4pcs)

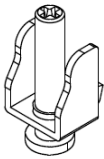

• Power Connector 1pc



• Gasket 1pc (preinstalled to unit)

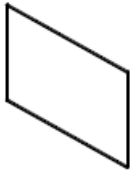

2.2 Names and Functions of Each Parts

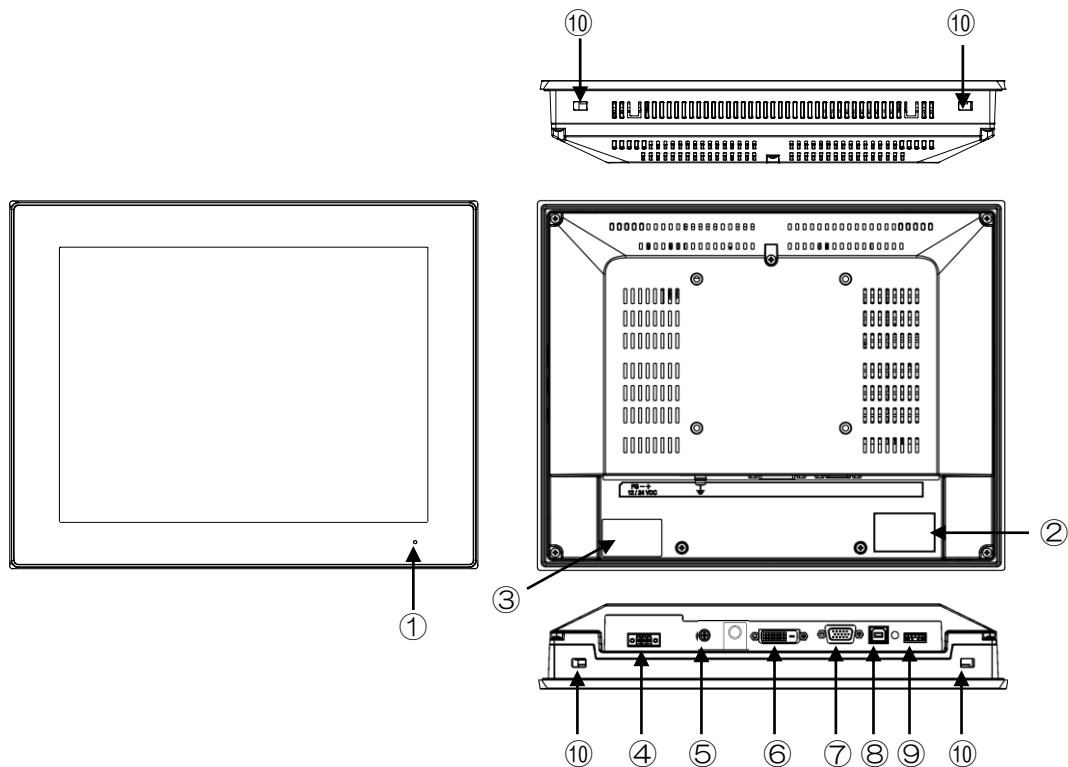

①	Power indicator	Displays power and input signal status Green: Power is ON with input signal Red: Power is ON without input signal Unlit: Power not applied
②	Product Labels	Product model, S/N, and ratings are noted
③	FCC Label	FCC statement
④	Power Connector	Connects to accessory connector
⑤	FG Terminal	Connects with FG cables
⑥	DVI Connector	Image signal input connector Connects with DVI cable
⑦	Analog RGB Connector	Connector for image signal input Connects with D-SUB15 Pin (Mini) Cable
⑧	USB-B type Connector	Touch screen I/F connector Connects to USB cable
⑨	Dial Switch	Use for operating power (ON/OFF) and OSD
⑩	Mounting Hole	Used when installing with mounting brackets

2.3 Panel Installation

Design referring to the panel opening measurement specified in product specification and the outline diagrams.

Make sure power is not applied when installing

Make sure the unit is not deformed or contorted when installing. Any contortion or deformation may result in insufficient protection.

Note

- Please use metal material when mounting the panel.
- Recommended panel thickness range may not be able to maintain the strength when impact is applied depending on the material and size.
- Please consider to reinforce the panel to withstand any impact.
- There is a possibility of personal injury or product damage when dropped. Please be careful not to drop the product.

2.3.1 Installation Conditions

When mounting to panels, be sure to have enough room to insert and remove the cables and the mounting brackets.

- Consider specification temperature between TM and the structure or parts, and be sure to have good ventilation.
- Use in specified ambient operating temperature and ambient operating humidity. (Ambient operation temperature indicates the temperature inside the cabinet where it is installed as well as the display side.)

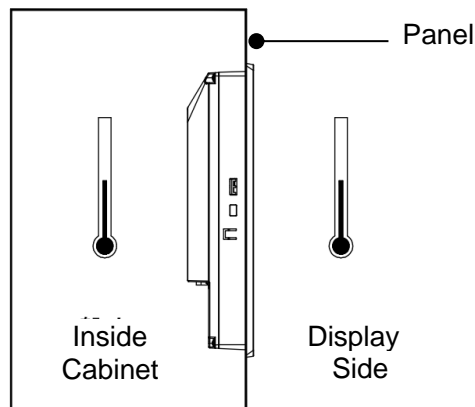

- TM should be installed perpendicular. When installing in an angle, the tilt shall be no more than 30°.

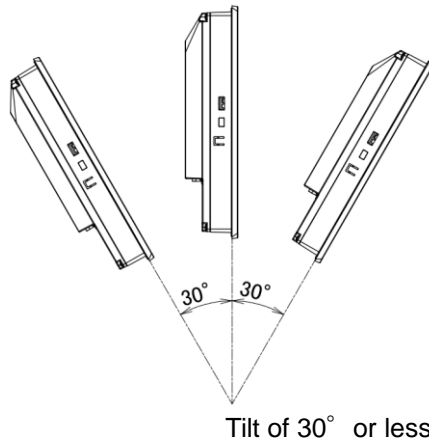

- When installing the TM in a slanted panel in an angle of more than 30 degrees, use forced air cooling and design so that the monitor display area is within the specified operation temperature.

2.3.2 Installing the Gasket

Please install the gasket even in environments where it may not seem necessary.

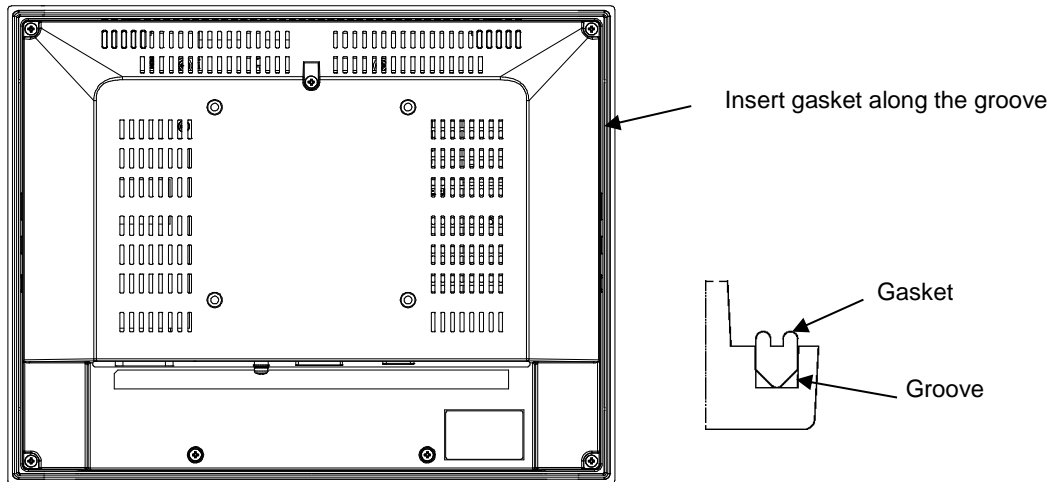

- * Gasket will be installed to the unit before shipment. Make sure it is properly installed before use.
- * A gasket used for a long time or have once been installed may have scratches or dirt on it and could have lost much of its protection effect. In order to maintain the stable protection effect, be sure to change the gasket on a regular basis.

2.3.3 Installation Procedure

- 1) Install the unit (with gasket) to the panel from the front.

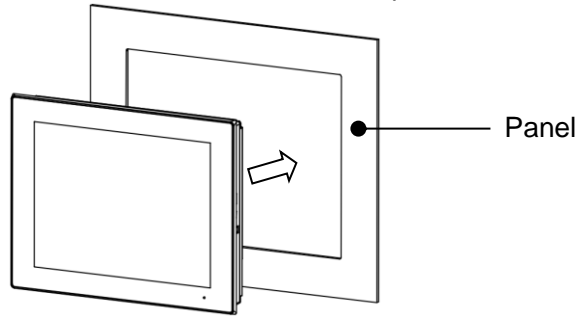

- * Make sure it is installed in the correct up-right direction.

- 2) Insert the hooks of the mounting brackets into the mounting holes in the four locations of the unit.

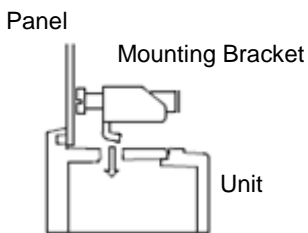
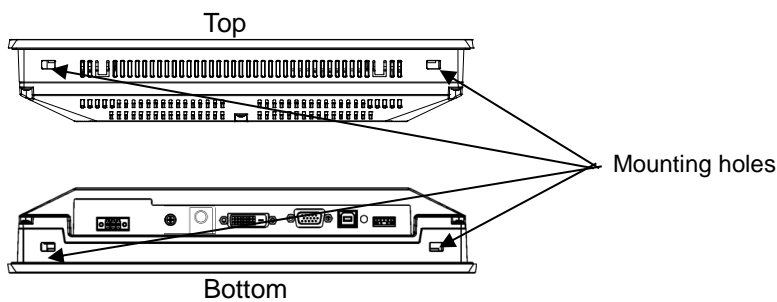

- 3) Tighten screw of mounting bracket and slide the bracket. Tighten the screw a little at a time in four locations working diagonally. Appropriate torque for tightening varies depending on the model. Please refer to below chart for the appropriate torque.

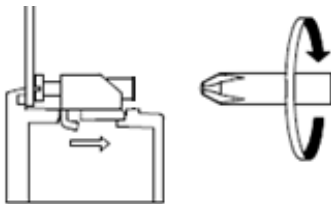

Model	Appropriate torque
TMH-310-DC00-01	0.7N·m
TMH-312-DC00-01	1.0~1.2N·m

Note:

- If the screw of the mounting bracket is not perpendicular to the panel, the unit might fall from the panel.
- If screw is too tight, the unit might deform or damage. Please tighten with appropriate torque.

2.4 Installing to Stands

2.4.1 Installing to “VESA Standard” Arms VESA”

TM can be installed to a commercially available Video Electronics Standards Association (VESA) arm.

If a stand is used, it must meet the UL1678 standard.

Refer to manual of arm or stand for installation procedures.

Mounting hole dimension is as below

VESA Standard 100mm×100mm

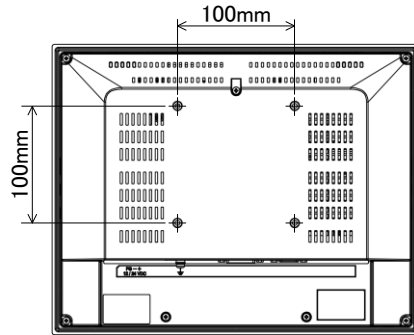

Use M4 screws and tighten with torque of 0.7 to 0.8N • m.

The penetration depth of the M4 screws shall be no more than 8mm.

VESA Standard

VESA is an abbreviation for “Video Electronics Standards Association”, an industry group that establishes standards concerning displays for computers.

VESA establishes SVGA standards and VL bus standards, and standardized below 2 types for the installation of LCD monitors.

- 75mm×75mm pitch
- 100mm×100mm pitch

TM complies with the VESA standard for 100mm x 100mm.

2.5 Wiring

Be sure no power is applied when making connections to avoid the risk of human injury or damage to equipment due to electrocution.

Do not turn the power on until all connections have been made.

Prepare the cables to be used according to the specifications.

2.5.1 Connecting Input Power

■Using Accessory Connectors

Accessories of this product include Euro terminal connector for power

Connect the power using the attached accessory cable.

■Connector Specification

Power Connector : 284510-3 by Tyco Electronics

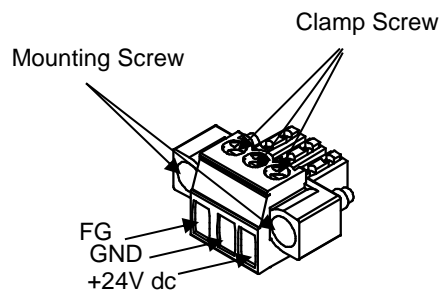

Clamp Screw Size : M2

Mounting Screw Size : M2.5

Torque : 0.3N·m

■Compliant Wire

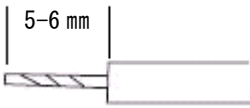
Wire type	Single wire, Stranded wire
Conductor size	AWG14-30
Wire Stripping Length	5-6 mm 

When using stranded wire, the twisting of the core wire must be appropriate in order to avoid fine wires of the core wire from short circuiting with each other or electrodes nearby.

■Wiring Procedures

Wire the power cables as instructed below.

- (1) Make sure power is not conducting.
- (2) Loosen the screw clamp on the connector.
- (3) Strip the cable; twist the core wire and insert to connection.
- (4) Tighten the screw clamp and fix the wire.
- (5) Connect the connector to interface of unit.
- (6) Tighten mounting screw and fix to unit.

■Cautions for Power Supply Wiring

- (1) Wire the power source, input/output device, and power device of the TM isolating each by sequence.
- (2) Do not bundle main circuit (High voltage, high current) wires, signal wires, and power cables, nor put them close to each other.
- (3) Twist the power cable as short as possible to improve noise immunity.
- (4) If there are any noise effects, attach a ferrite core to the power cable.
- (5) A Safety Extra Low Voltage (SELV) and Limited Energy Circuit or SELV and Class 2 dc power supply.
- (6) The user calculates proper gauge wiring for current carrying capacity and loss according to local regulations.
- (7) Connect a lightening surge absorber for lightening surge measures.
- (8) Separate lightening surge absorber connection (E1) and grounding of TM (E2).
- (9) Choose the lightening surge absorber so the power voltage maximum increase does not exceed the maximum capacity voltage circuit of the lightening surge absorber.

■Cautions for Grounding

- (1) Have a dedicated grounding for power source cable FG.
" Grounding resistance of 100Ω , 2mm^2 [0.0062inch^2] or thicker wire, or your country's applicable standard."
- (2) SG (Signal ground) and FG (Frame ground) is connected inside of TM. When connecting connection apparatus and SG, design the system so there is no short circuiting loop.
- (3) Use a grounding wire of 2mm^2 or more. Shorten the grounding wire distance near the grounding point of TM. If the grounding wire is long, than use a large insulation wire when setting.

2.5.2 Wiring Procedure

- 1) Make sure all powers are off and there is no electricity flow to either the TM or the computer.
 - 2) Connect the TM and the computer as the following diagram.
- * Please connect to the power source last.
 - * Install the Ferrite Core to the cable if noise measures are necessary.

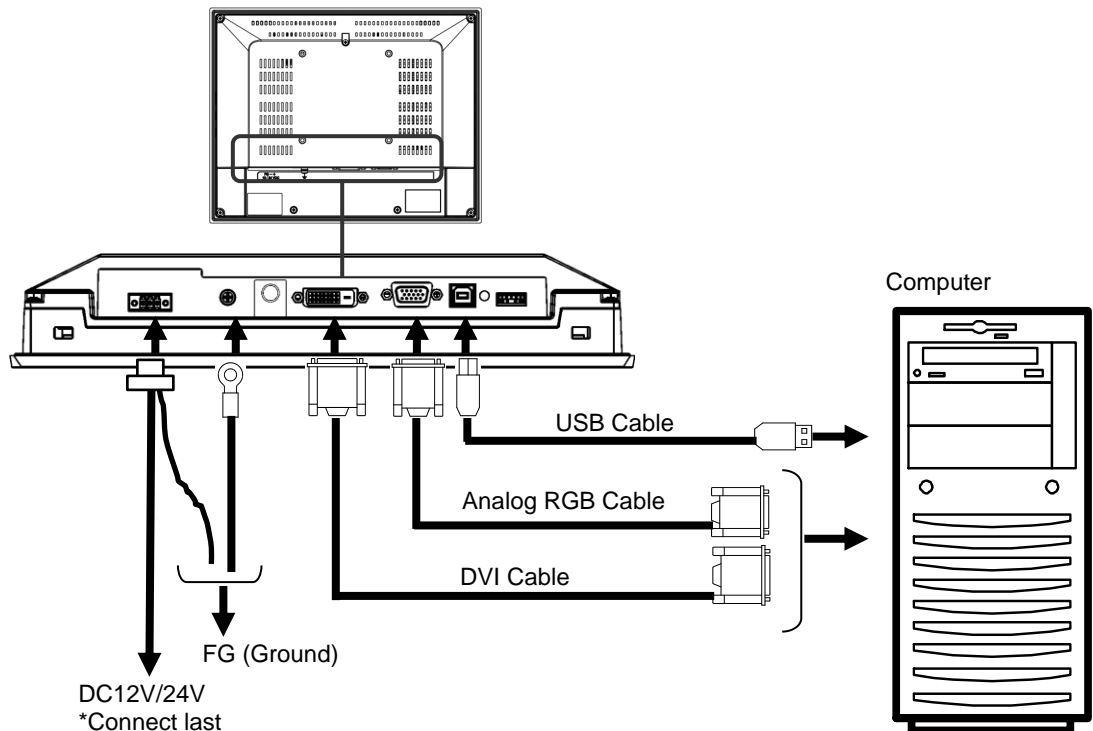

Note)

When using the analog RGB cable, you may see misalignment or flickering of the screen. Make display adjustments to improve these phenomena. Refer to [“3.2.2 Adjusting Display Screen”](#) for details.

2.6 Operations

The dial switch on the back side of the TM can be used to operate the OSD (On Screen Display) and turn the power ON or OFF.

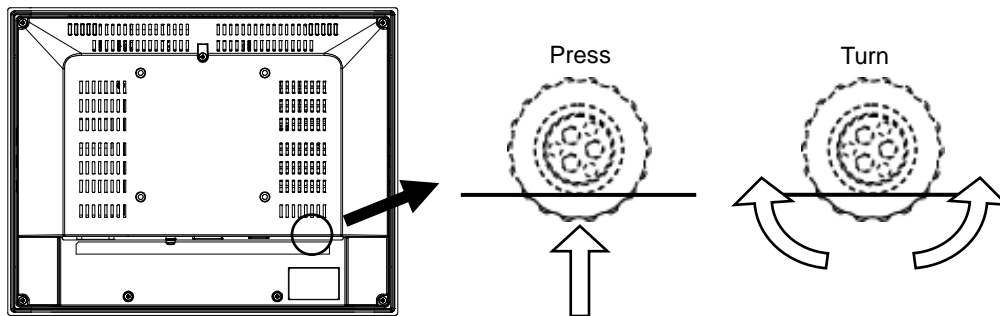

2.6.1 POWER ON/OFF

Press switch to turn on the monitor.

Press and hold the switch for more than two seconds to turn the power off.

* Wait five seconds before turning back on the power after turning the power off.

2.6.2 OSD Operation

Press the switch when the TM display is ON to start the OSD.

Adjust the value or the selected item by turning the switch clockwise or counter-clockwise.

Push switch to determine the chosen item and/or the value.

3. OSD

Various configurations and adjustments can be made with the OSD (On Screen Display).

OSD is operated with a dial switch.

The value set will be retained and will not be deleted when power is shut down and until setting is changed intentionally.

Chapter Contents

3.1	OSD Menu	15
3.2	OSD Menu Operation	16

3.1 OSD Menu

Top menu icons



Main Menu	Submenu	Adjustment range	Initial Value	Description
PICTURE 	Brightness	0 ~ 100	80	Adjust brightness of display
	Contrast	0 ~ 100	50	Adjust contrast of display
	Sharpness	0 ~ 4	2	Adjust sharpness of display
	Exit	-	-	Go back to main menu
DISPLAY (Can only be used with Analog RGB) 	Auto Adjustment	-	-	Automatically adjust DISPLAY items
	H Position	0 ~ 100	50	Adjust horizontal position of display.
	V Position	0 ~ 100	-	Adjust vertical position of display
	Pixel Clock	0 ~ 100	50	Adjust clock on display
	Phase	0 ~ 100	50	Adjust phase (position) of display
	Exit	-	-	Go back to main menu
COLOR 	Gamma	OFF	OFF	Adjust Gamma value
		1.8		
		2.2		
	Color Temp	2.4	6500K	Adjust color temperature
		5800K		
		6500K		
	Color Effect	7500K	Standard	Adjust color effect
		9300K		
Auto Color	sRGB	Standard	Adjust R : Y : G : C : B : M individually 0 ~ 100	
	User			
Exit	-	-	Automatically adjust color tone	
	-	-	Go back to main menu	
INPUT 	Auto Select	-	Auto Select	Automatically select image input
	VGA	-	Auto Select	Switch image input to analog RGB
	DP	-		N/A
	DVI	-		Switch image input to digital DVI
	Exit	-	-	Go back to main menu
AUDIO 	Volume	0 ~ 100	80	N/A
	Mute	ON/OFF	OFF	N/A
	Exit	-	-	Go back to main menu
OTHER 	Reset	-	-	Reset to initial value
	Menu Time	0 ~ 30	10	Set time display of OSD menu
	OSD H Position	0 ~ 100	50	Adjust horizontal position of OSD menu
	OSD V Position	0 ~ 100	50	Adjust vertical position of OSD menu
	Transparency	0 ~ 7	0	Adjust transparency of OSD menu
	Exit	-	-	Go back to main menu
EXIT 	-	-	-	Exit OSD

3.2 OSD Menu Operation

3.2.1 Basic Functions

Displaying the OSD

- 1) Press the dial switch to display the main menu of the OSD.
(No actions will be performed by turning the dial switch without displaying the OSD first.)

Selecting with the OSD

- 1) Choose the item (icon) on the OSD by turning the dial switch while OSD is displayed. The item in yellow is the item in the selected state.
- 2) Press the dial switch to determine the selected item.
- 3) If the sub-menu is displayed, choose the item in the same procedure as 1) and 2).
- 4) Turn the dial switch to change the value of the "Bar Meter" and press to determine the value.
*The determined value will be retained in the TM. It will not change even after the power is turned OFF.

Exiting the OSD

- 1) After making the adjustments, select [EXIT] of the sub-menu to go back to the main menu.
- 2) Select [EXIT] of the main menu to end the OSD.
*If an operation is aborted, the OSD will automatically end at the time set on the OSD Timer.
Refer to "[3.2.6 Setting Auto Close Time of OSD Menu](#)" for how to set the OSD Timer.

3.2.2 Adjusting Display Screen

Automatic adjustment will start if input by analog image signal.
If the display is not appropriate, try automatic adjustment by below procedure.

- 1) Open OSD menu
- 2) Select [DISPLAY] > [Auto Adjustment].
- 3) Auto adjustment will start.

Note)

- When using the [Auto Adjustment], please note the following points.
 - It will work properly if the image is fully displayed in the display area and not only on a part of an area on a black background.
 - Display the screen in the entire display area.
 - Use an image with many vertical lines.
- Auto adjust will sometimes not display properly depending on the signals from the analog image signals.
Make adjustments with the [Pixel Clock] or [Phase] in the sub-menu of the [DISPLAY] icon when necessary.

3.2.3 Adjusting Brightness

- 1) Open the OSD menu.
- 2) Select [Picture] > [Brightness].
- 3) Turn the dial switch to adjust the "Bar Meter" value.
(The screen brightness will change with the turn of the dial.)
- 4) Press the dial switch to determine the brightness you desire.
- 5) End OSD.

3.2.4 Changing Color Temperature

- 1) Open the OSD menu.
- 2) Select [COLOR] > [Color Temp].
- 3) Choose the color temperature.
- 4) Select [User] to adjust the "R", "G", and "B" individually.
- 5) End OSD.

3.2.5 Auto Adjusting Color

If color tone is not right or the values are reset to the initial values, try auto adjusting the color.

- 1) Display "One tone: White" on the entire screen. *Do not display other windows.
- 2) Open the OSD menu.
- 3) Select [COLOR] > [Auto Color].
- 4) Automatic adjustment will start and the OSD menu will close automatically.

Note)

Depending on the liquid crystal solidity difference, you may not necessarily get the color you expect.

3.2.6 Setting Auto Close Time of OSD Menu

Set the time to automatically close the OSD menu.

The set time is [Set Value] x seconds. Enter "0" to display constantly.

Please note, even if the value is not determined, the value selected when the OSD closes automatically will be selected menu.

- 1) Open the OSD menu.
- 2) Select [OTHER] > [Menu Time].
- 3) Turn dial switch and change value of the "Bar Meter".
- 4) Set to desired time.
- 5) End OSD.

3.2.7 Return to Initial Values

Return the values of the OSD to the initial state.

- 1) Open the OSD menu.
- 2) Select [OTHER] > [Reset].
- 3) Perform "[3.2.5 Auto Adjusting Color](#)".

4. Mouse Emulation Software

The mouse emulation software “TSC-DD” can be downloaded via our web site. Be sure to download the driver that suits your computer bit size.

URL : <http://www.seedsware.co.jp/support/download/>

Chapter Contents

4.1	System Requirements	19
4.2	Installing Procedure	20
4.3	Multi-monitor Setting.....	25
4.4	Calibration	26

4.1 System Requirements

4.1.1 System Configuration

Supporting OS : Windows 7 (64bit)
 Windows 8/8.1 (64bit)
 Windows 10 (64bit)

Note:

Contact us for information concerning the operation check of Windows 8/8.1/10.

4.1.2 Installment Requirements

- Hardware
There must be 10MB of free space and data file storing capacity in the system drive.

4.1.3 Others

- 1) When using Windows 7 and inputting by touch on the multi-monitor, the graphic driver must support DirectX9 and be WDDM 1.0 or of greater version.
- 2) Touch screen operation will be single touch mouse input only.

4.2 Installing Procedure

4.2.1 Installing the “Mouse Emulation Software”

* This is the procedure for customers without the Japanese character when using with Windows XP, Microsoft .NET Framework 2.0/3.0/3.5, without the Japanese Language Pack.

- (1) Unzip the software compressed file downloaded to the computer to be used.
- (2) USB cable should not be connected at this point.
- (3) Double click the  “Installer.exe” icon.
- (4) .NET Framework2.0(x86) installation confirmation window will be displayed.
- (5) Review the License Agreement for adding of Microsoft Software. If you can agree to the License conditions, select [I Agree].
- (6) After 「.NET Framework2.0」 is installed, a Setup Wizard will start. Click [Next] and start the installation.

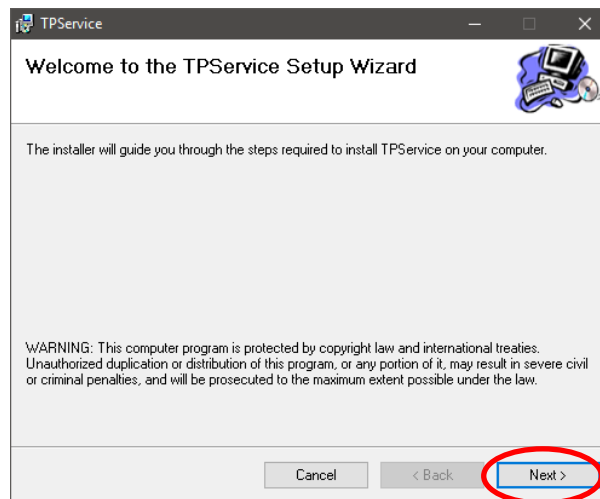

- (7) Review the License Agreement. Select [I Agree] and click [Next].

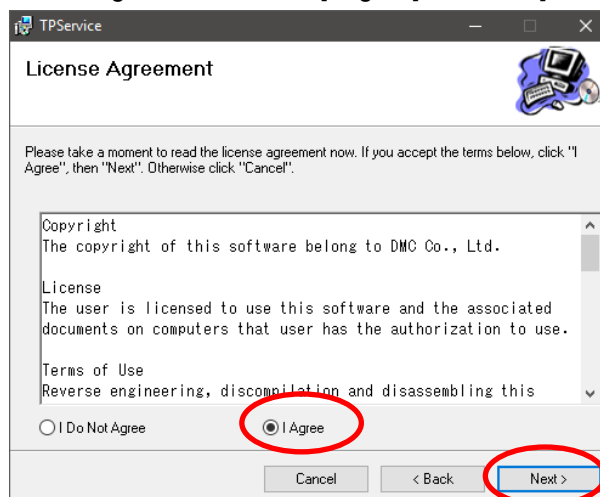

- (8) "Select Installation Folder" window will appear. If you do not have to make any changes in the folder destination, click [Next], Or if you do have to make changes, click [Browse], specify your folder destination and click [Next].

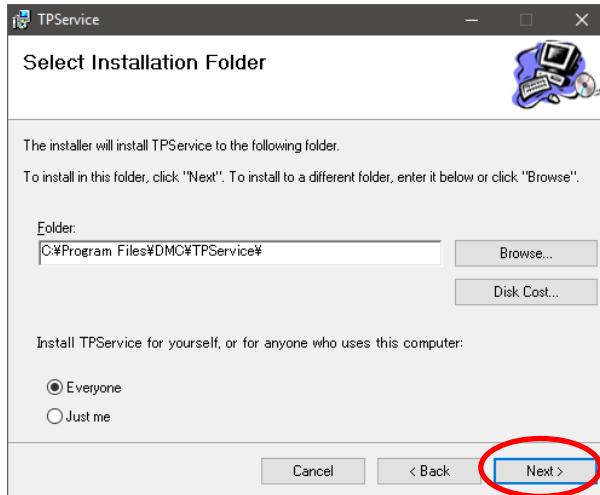

- (9) "Confirm Installation" window will appear. Click [Next].

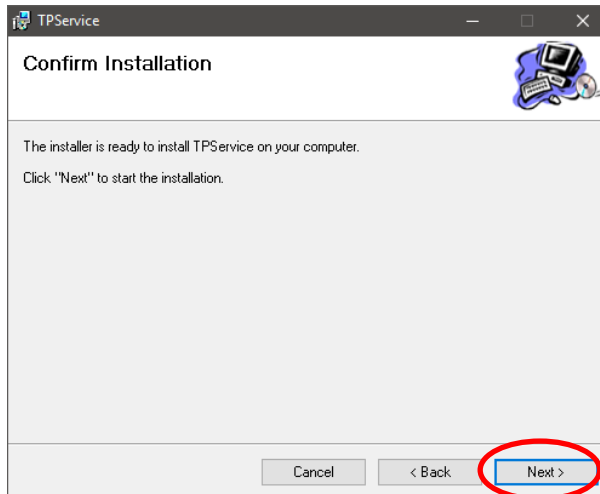

- (10) You may see a message dialog as below several times during the installation. Click [Install] or [Continue Anyway].

For Windows 7/8/10



For Windows XP

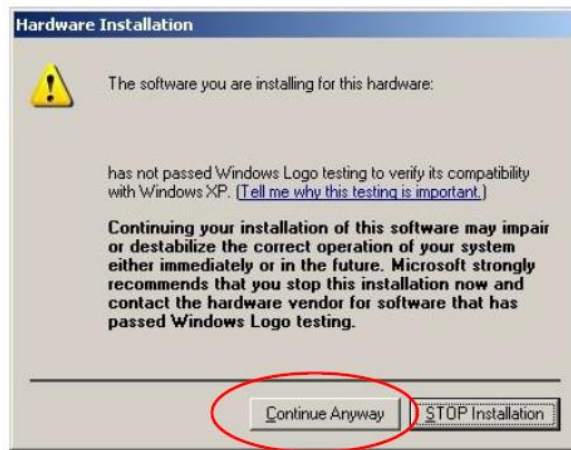

(11) Installation is complete. Click [Close] to end the Wizard.

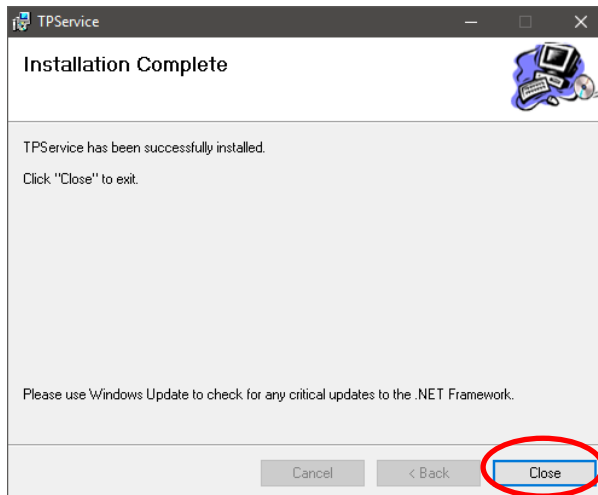

(12) A window as below will appear. Click [Yes] and reboot your computer.

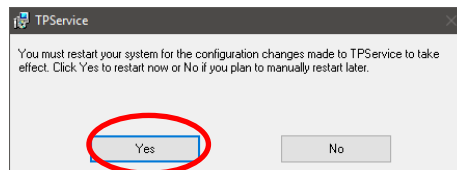

4.2.2 Installing the Touch Screen Driver

- 1) Connect the TM and the computer with an USB cable.
- 2) Installation of the driver will start.
- 3) If a window as below appears, install the driver according to the procedure below. Select “No, not this time” and click [Next].



- 4) Choose “Install the software automatically (Recommended)” and click [Next].

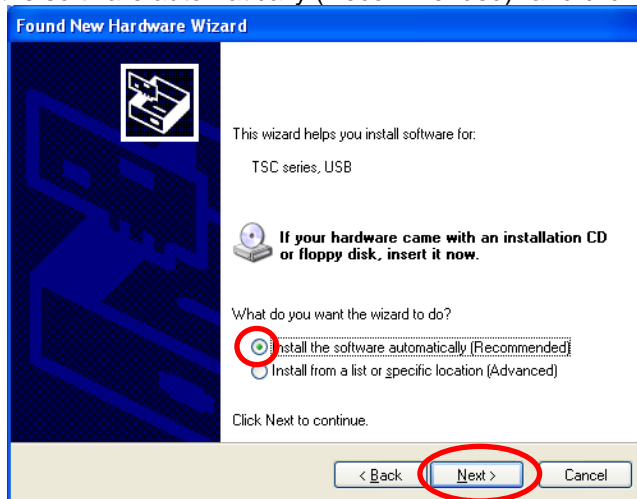

- 5) Installation is complete. Click [Finish] and close the window.

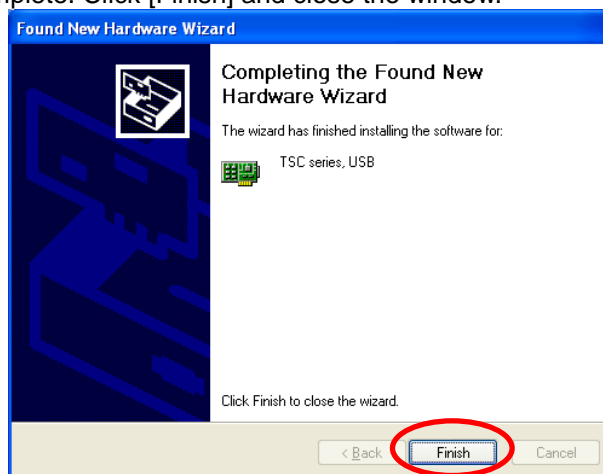

- 6) Select [Start] > [All Program] > [DMC] > [DMC Touch Panel Configuration] and open the "Properties" window.
- 7) If "USB controller 0" is displayed, then the driver has been installed successfully.

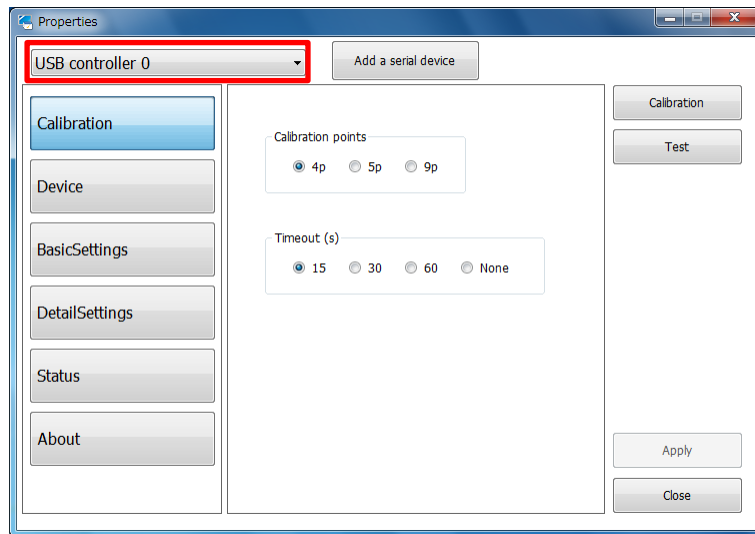

4.3 Multi-monitor Setting

The TM can be used for both “single monitor” and “multi-monitor”. Below is the procedure to set as a “multi-monitor”

- 1) Select [Start] > [All Program] > [DMC] > [DMC Touch Panel Configuration] and open the “Properties” window.
- 2) Click [Device] and open the device screen.

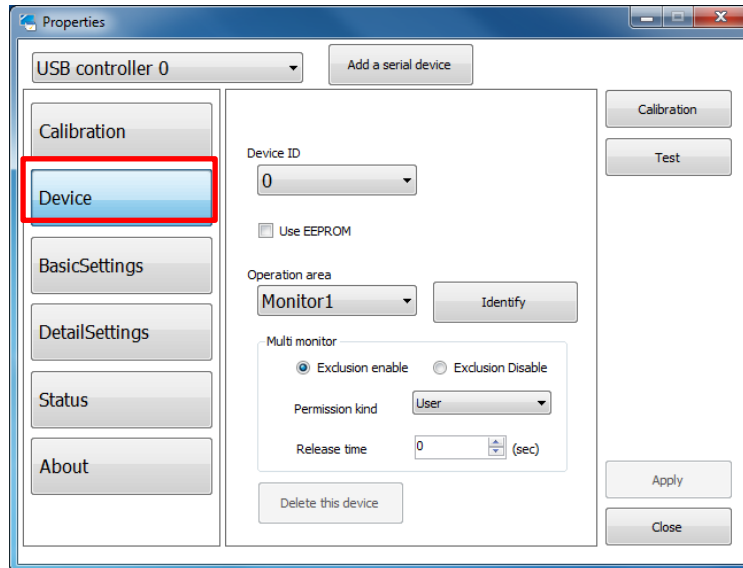

- 3) Click [Identify] and the number of the monitor will be displayed in the center of the TM display.
- 4) Choose the monitor number in the [Operation area] to the number displayed on the TM.
- 5) Click [Apply] to reflect the setting.

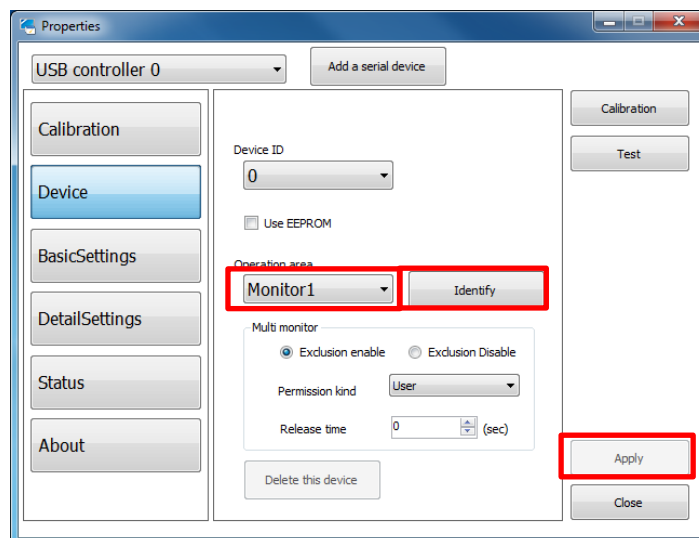

4.4 Calibration

4.4.1 Save Location Setting of Calibration Data

Calibration data of the touch screen can be either “stored in the TM” or “stored in the computer”. The initial setting will be “store in the TM”.

Follow below procedure to set the save location of the calibration data.

- 1) Select [Start] > [All Program] > [DMC] > [DMC Touch Panel Configuration] and open the “Properties” window.
- 2) Click [Device] and open the device screen.

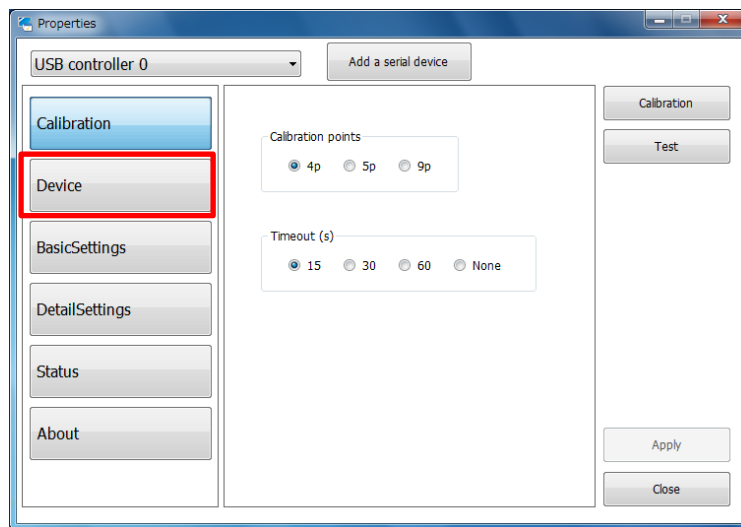

- 3) Place a check in the box of [Use EEPROM] to enable EEPROM and save the calibration data in the TM unit.

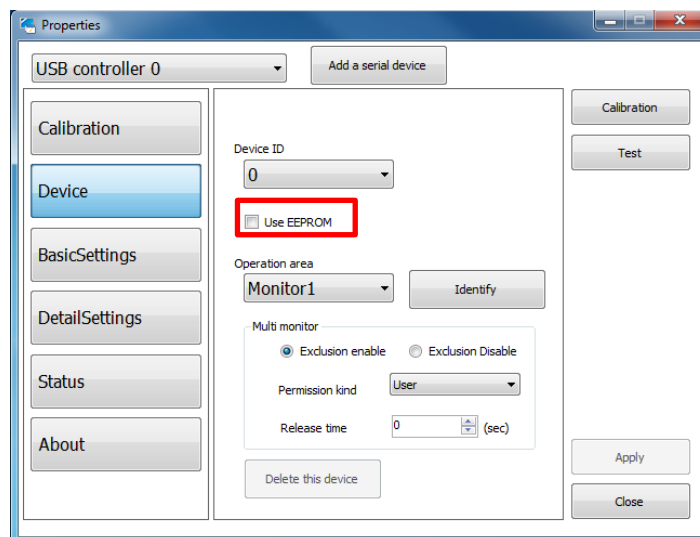

4.4.2 Calibration

Below is the procedure for “4 points touch screen calibration”.

- 1) Select [Start] > [All Program] > [DMC] > [DMC Touch Panel Configuration] and open the “Properties” window.
- 2) Choose [4p] of the “Calibration points” and click [Calibration].

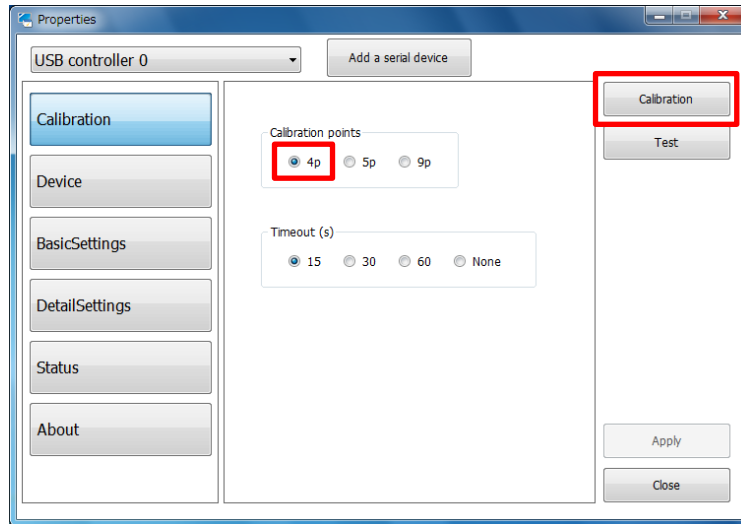

- 3) TM will display a screen as below diagram (1).
- 4) Touch the red center of the blue cross “+” displayed.
- 5) The cross will turn red “+” as shown in (2) and another blue cross “+” will appear on the display.
- 6) Touch the red center of the newly shown blue cross “+” and repeat in order shown below.

* Use of a touch pen is recommended.

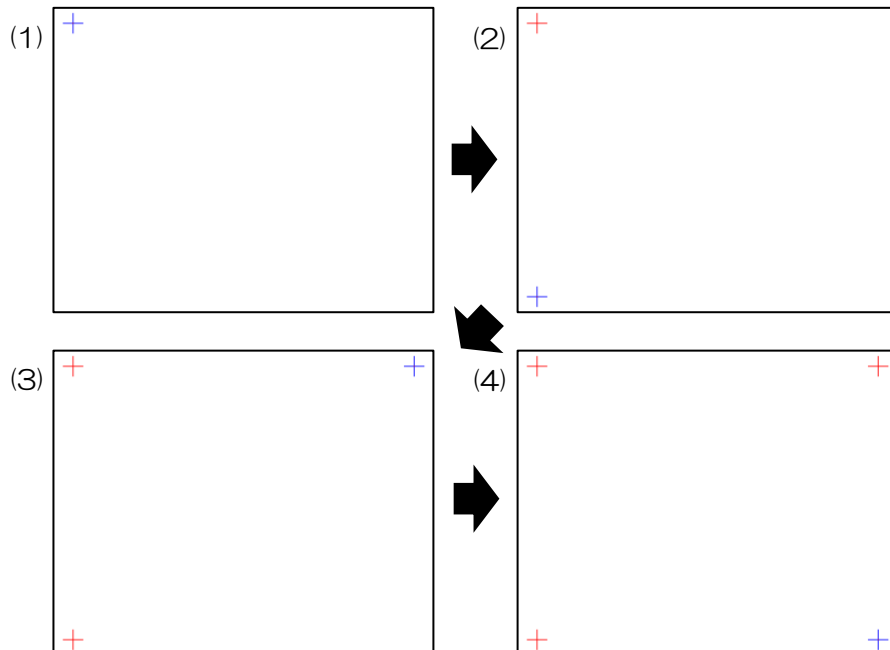

7) After all crosses have been touched, below screen will appear.

* When touching the red center of the blue cross “+”, if an area anywhere on the screen is touched and not the cross, it will be recognized as the blue cross and thus will have the wrong calibration results. Be sure to touch the red center of the blue cross.

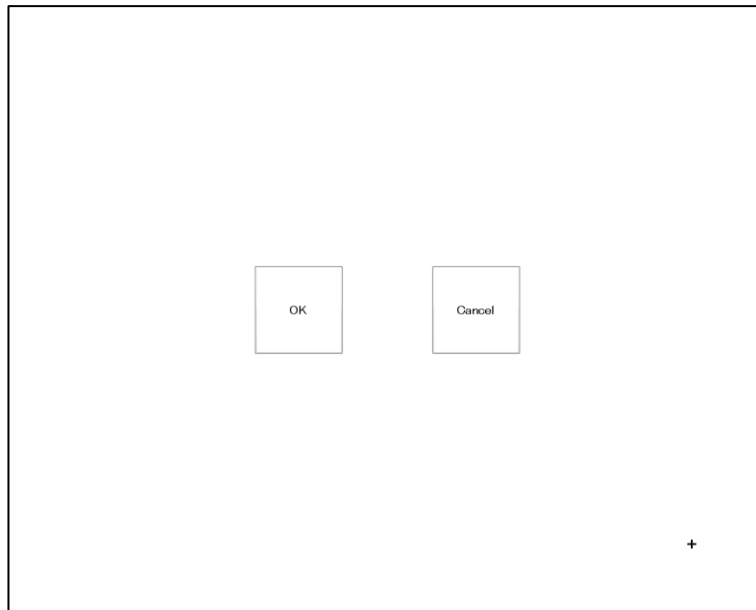

8) Touch anywhere off the [OK]/ [Cancel] and make sure the touch points are not wrong.

9) To set the calibration data, tap [OK].

10) To cancel the calibration, tap [Cancel].

* For a more detailed procedure or other information, refer to “readme.pdf” included in the “Mouse Emulation Software”.

5. Maintenance

Chapter Contents

5.1	Maintenance	30
-----	-------------------	----

5.1 Maintenance

5.1.1 Display

If the display surface or the frame gets dirty, wipe with a soft cloth damped in mild detergent than wrung dry.

⊘ Uses of thinner, organic solvents, strong acidic detergents are prohibited.

5.1.2 Periodic Check

To keep the product in its best condition, check periodically for below points.

- Ambient Environment
 - (1) Ambient temperature is within the specified range (0~50°C)
 - (2) Ambient humidity is within the specified range (10~85%RH (No condensing, wet-bulb temperature is 39°C or below))
 - (3) Operating pressure is within the specified range (800~1114hpa)
- Electrical Specification
 - (1) Voltage is within the permissible range (DC12V±20% / DC24V±20%)
- Installation
 - (1) Connectors of the cable are inserted securely.
 - (2) Fixtures are tightly installed and are not loose.

6. Troubleshooting

If problems still remain and cannot be solved, contact your dealer or refer to [7.3 Inquires](#) and contact us.

Chapter Contents

6.1	Display	32
6.2	Touch Screen.....	33

6.1 Display

No	Symptoms	Cause/Measures
1	<ul style="list-style-type: none"> No display (LED will not light) 	<ul style="list-style-type: none"> Make sure the power cord is inserted securely. Press the dial switch and turn ON the power of the TM.
2	<ul style="list-style-type: none"> No display (LED lights red) 	<ul style="list-style-type: none"> Check that the image signal cable is inserted properly. Make sure the power of the computer is on. Check if the image output of the computer is properly output.
3	<ul style="list-style-type: none"> Display is dark 	<ul style="list-style-type: none"> Adjust the Brightness. Refer to "3.2.3 Adjusting Brightness".
4	<ul style="list-style-type: none"> Display is misaligned (when input with analog RGB) 	<ul style="list-style-type: none"> Try the Auto Adjustment. Refer to "3.2.2 Adjusting Display Screen". Adjust "H Position"/"V Position" by OSD [Menu] > [Display].
5	<ul style="list-style-type: none"> Vertical lines (bars) appear on the screen Part of screen is flickering. 	<ul style="list-style-type: none"> Try the Auto Adjustment. Refer to "3.2.2 Adjusting Display Screen". Adjust "Pixel Clock" by OSD [Menu] > [Display].
6	<ul style="list-style-type: none"> Entire screen is flickering Right/Left of screen is not displayed 	<ul style="list-style-type: none"> Try the Auto Adjustment. Refer to "3.2.2 Adjusting Display Screen". Adjust "Phase" by OSD [Menu] > [Display].
7	<ul style="list-style-type: none"> Afterimages appear 	<ul style="list-style-type: none"> Afterimages can be seen if the same image is displayed for a long time. Use the screen saver or the OFF timer function to avoid image burn-ins.
8	<ul style="list-style-type: none"> Red, green, blue, and white dots can be seen on the screen. There is a defective dot on the screen. 	<ul style="list-style-type: none"> This is a characteristic of the LCD and not a failure.

6.2 Touch Screen

No	Symptoms	Cause/Measures
1	<ul style="list-style-type: none">• Cursor position is not correct• Cursor jumps	<ul style="list-style-type: none">• Remove then insert again the USB Cable that connects to the computer.• Make sure that the FG (Frame GND) of the TM and the FG (Field GND) of the powers are connected.• Try touch screen calibration. Refer to "4.4 Sensor Calibration" for details.
2	<ul style="list-style-type: none">• Touch operation is not effective	<ul style="list-style-type: none">• Make sure the USB cable used to connect to the computer is connected securely and properly.• Reboot the computer.• Check that the touch screen driver is installed properly.
3	<ul style="list-style-type: none">• There is no touch sound	<ul style="list-style-type: none">• Touch sound may not be output depending on the computers configuration.• Choose to or not to output touch sound from the touch screen driver.

7. Others

Chapter Contents

7.1	Warranty and Repair.....	35
7.2	Production Discontinuance	36
7.3	Inquiries	37

7.1 Warranty and Repair

7.1.1 Warranty

The warranty period is limited to 12 months (1 year) from the date of shipment from our factory. Warranty for any repair needed to the same repaired part of the same product is three months. Any defects that occur upon normal use under conditions specified herein will be repaired (factory repair) free of charge.

Any defected parts under proper use will be examined by the supplier and replaced by the new parts if the defect is considered to be caused by the supplier.

Warranty Exceptions

You will be liable for all repair fees even within the warranty period for any conditions listed below:

- 1) Any malfunctions, defects, and/or damages that occurred during transport, transfer, or mishandling by the user after delivery
- 2) Any malfunctions, defects, and/or damages caused by natural or man-made disaster.
- 3) Any malfunctions and damages caused by static electricity.
- 4) If the product is used under any condition, in any environment, or by any method other than those specified in the specifications, catalogs, manuals, notes, and/or other documents.
- 5) Any replacement of consumables.
- 6) Any malfunctions, defects, and/or damages caused by associated equipment and/or usage of inappropriate consumables and media.
- 7) If the product is repaired, remodeled, modified, or disassembled by a party other than Seedsware
- 8) If the product cannot be identified by a serial number.
- 9) Any malfunctions, defects, and/or damages that are to have been caused on your behalf.

This warranty covers only the product itself. Any damages, on-site repairs and replacement driven by the failure of the product will be decided upon discussion by both parties as necessary. This product is structurally not repairable. All damaged parts are subject for replacement and freight will be charged.

7.1.2 Repair Conditions

- 1) Only Seedsware products can be repaired. Options are exempt.
- 2) Repairs will be done in our workshop after it is sent back. All shipping fee will be charged.
- 3) Seedsware will have all ownership for parts exchanged at repair.

7.1.3 Inquiries for Repair

If you have any inquiries concerning defects or repairs of our products, feel free to contact us. When doing so, please confirm the issue or the symptom before making inquiries. Also, when sending us the product, please include a fully filled "Repair Request" form with the issue or the symptom noted.

And please, make sure the product is packaged so it will not get damaged during shipment.

■ Where to Contact:

USCO America Inc.

Phone: +1-630-832-0438 (Business Hours 9:00a.m to 5:45p.m., CT)

E-mail: sales@uscoamerica.com

7.2 Production Discontinuance

In the event of production discontinuance, an announcement will be made on our website six months prior to the last possible order reception date.

7.3 Inquiries

For comments or inquiries, feel free to contact us via e-mail or phone.

* Product, specification and/or anything noted are subject to change for improvement without prior notice.

By Phone

 **+1-630-832-0438 (Business Hours 9:00a.m.~5:45p.m., CT)**

By E-mail

 **sales@uscoamerica.com**

FAQ

 www.seedsware.co.jp/global/support/faq/

Microsoft®, Windows® XP, Windows Vista®, Windows® 7, Windows® 8, Microsoft® .NET Framework, Windows® 10 are trademarks and registered trademarks of Microsoft Corporation USA in the United States and other countries. Other product/company names mentioned herein are also trademarks/registered trademarks of their respective owners.

2nd Edition October, 2016

USCO America Inc.

136 W. Valletts Street, Elmhurst, IL 60126 USA

Phone: 630-832-0438/510-931-9046

E-mail: sales@uscoamerica.com

Business hours: 9:00a.m. to 5:45p.m. (Central Time)

<http://uscoamerica.com/>

This document is protected by copyright law. Photocopying, duplicating, reproducing, and modifying of this product or document in part or by whole is prohibited.

Copyright(C) 2016 Seedsware Corporation. All Rights Reserved
